

高清智能网络摄像机
HD Intelligent IP Camera

KEDACOM

快速安装指南
Quick Start Guide

一 前言

感谢您购买我司产品，如对本公司产品有疑问或需要，请随时和我们联系。

此内容（手册）的目的是确保用户正确使用本产品，以避免危险或财产损失。在使用产品之前，请认真阅读此手册并妥善保存以备日后参考。如果用户因没有按照以下安全说明，致使设备不能正常使用或损坏等情况，我司恕不负责，感谢您的配合。

二 安全说明

1. 电源要求

- 请在安装使用设备过程中，严格遵守当地各项电气安全规定。
- 请使用满足安全电压要求的电源，在设备运行之前检查供电电源是否正确。
- 请在安装配线时装入易于使用的断电设备，以便必要时进行紧急断电。
- 请保护电源软线免受踩踏或紧压，特别是在插头、电源插座和从装置引出的接点处。
- 请在断电状态下连接网络、电源等线缆，严禁在设备上电的情况下连线。

2. 使用环境要求

- 请勿将摄像机对准强光（如灯光照明、太阳光等处）聚焦，否则容易引起过亮或漏光现象（这并非摄像机故障）也将影响摄像机寿命。
- 请在允许的湿度和温度范围内运输、使用和存储设备。
- 请勿将设备置于潮湿、多尘、极热、极冷、强电磁辐射或照明条件不稳定等场所。
- 请勿让任何液体流入设备，以免内部元件受损。
- 请勿阻挡设备附近的通风口，以免热量积蓄。
- 请在运送设备时，重新以出厂时的包装进行包装，或用同等品质的材质包装。
- 请勿在运输、存储及安装过程中重压、剧烈震动、浸泡设备。
- 请勿安装在不牢固的支架、墙面、或屋顶上，否则会导致人机受损。

工作环境	
供电要求	AC 24V±10%，50-60Hz
环境要求	防水、防干扰、防雷击
温度	-40°C~70°C
湿度	10%~95%(相对、无凝结)

3. 日常维护与保养

- 请勿直接触碰设备发热部件，以免烫伤。
- 镜头玻璃表面沾染灰尘或油脂时，用棉布或镜头清洁布擦拭。若遇污垢难以清除，蘸上少量镜片清洁剂，自镜头中心向外旋转轻轻擦拭，直到干净为止。禁止使用有机溶剂（苯、酒精等）对镜头玻璃和护罩前脸进行除尘、清洁。
- 请不要以任何方式拆卸或修改产品（对未经认可的操作导致的问题，本公司不承担任何责任）。
- 如果设备工作不正常，请联系经销商或最近的服务中心。

4. 特别声明

- 本手册中的图示仅供参考，产品请以实物为准。
- 我们尽最大努力来保证本手册信息的正确性，如因升级等原因发生信息修改，恕不另行通知。本手册能作为多个型号产品的使用指导，由于篇幅有限，不一一列举每个产品的使用情况，请您根据实际情况自行对照。
- 本产品使用 IPCSearch 激活后方能使用（IPCSearch 可在官网下载，下载链接 <https://www.kedacom.com/cn/softtools/index.jhtml>），激活时请填写有效邮箱，方便找回密码。强烈建议您将密码设置为强密码：由数字、大/小写字母或特殊符号中两种或两种以上类型组合而成，且密码长度满足 8-16 位。请您定期更改用户名的密码，建议每 3 个月更新一次密码。如果设备在较高安全风险的环境中使用，建议每月或每周更新一次。请妥善保管好您的用户名与密码。
- 如需获取最新文档，请至官网下载，官网地址 www.kedacom.com。

三 设备外观 设备尺寸

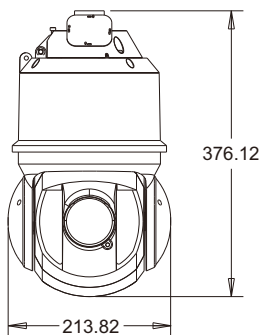

红外款

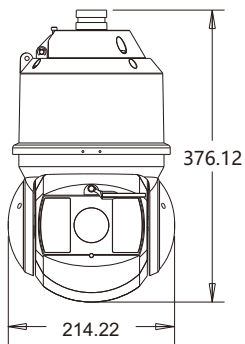

雨刷红外款

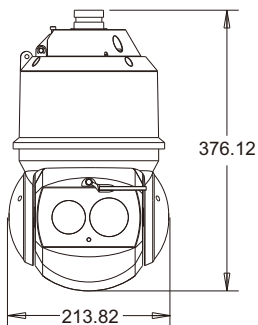

激光款

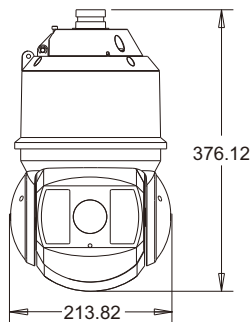

红外款

单位: mm
净重: 6.1Kg MAX

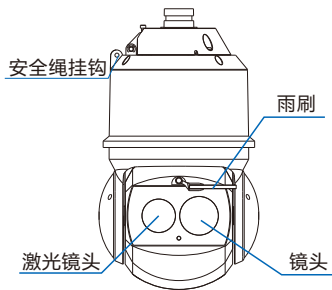

激光款

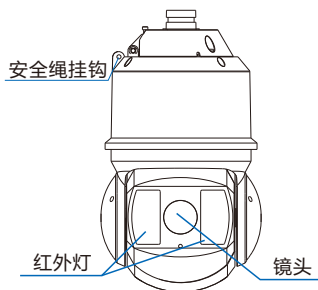

红外款

【说明】不同子型号部件有所区别，GPS天线、4G天线、WIFI天线为选配部件，请以实际产品设备为准。

尾线说明

尾线1

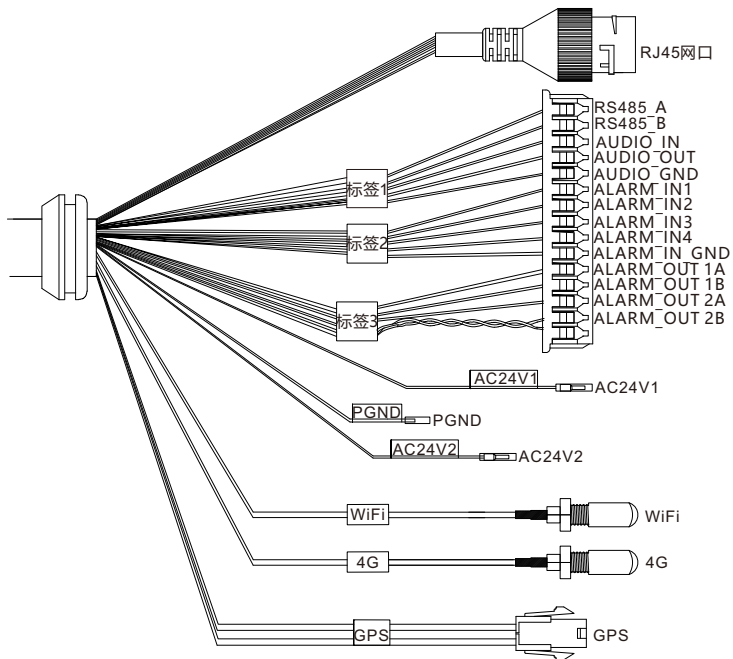

标签	颜色	功能说明	线序
RJ45网口	-	RJ45网口, 连接网络设备, 支持10/100Mbps自适应	-
RS485_A	黑	RS485串口, 与外接设备交互控制, 如控制第三方设备。	1
RS485_B	红		2
AUDIO_IN	灰	音频输入, 输入音频信号, 连接拾音器等设备	3
AUDIO_GND	黄	音频接地	4
AUDIO_OUT	蓝	音频输出, 输出音频信号, 连接音箱等设备	5
ALARM_IN1	白	告警输入, 输入告警信号, 连接声控开关等设备	6
ALARM_IN2	紫		7
ALARM_IN3	橙		8
ALARM_IN4	棕		9
ALARM_IN_GND	绿	告警输入接地	10
ALARM_OUT 1A	黑/白	告警输出, 输出告警信号, 端子不分正负。连接报警灯等设备。	11
ALARM_OUT 1B	红/白		12
ALARM_OUT 2A	粉红		13
ALARM_OUT 2B	棕/白		14
AC24V1	红	电源, 连接AC24V电源	-
PGND	黄绿	保护接地	-
AC24V2	黑	电源, 连接AC24V电源	-
WIFI	-	WIFI, 连接WIFI天线	-
4G	-	4G, 连接4G天线	-
GPS	-	GPS, 连接GPS天线	-

尾线2

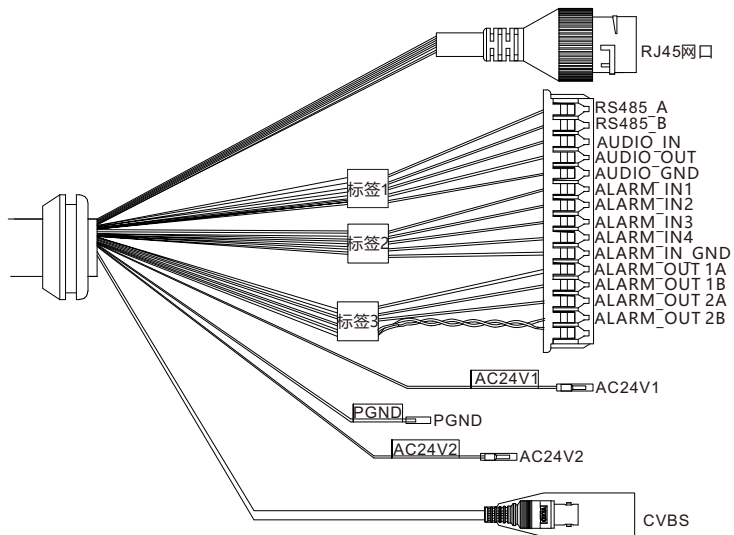

标签	颜色	功能说明	线序
RJ45网口	-	RJ45网口，连接网络设备，支持10/100Mbps自适应	-
RS485_A	黑	RS485串口，与外接设备交互控制，如控制第三方设备。	1
RS485_B	红		2
AUDIO_IN	灰	音频输入，输入音频信号，连接拾音器等设备	3
AUDIO GND	黄	音频接地	4
AUDIO_OUT	蓝	音频输出，输出音频信号，连接音箱等设备	5
ALARM_IN1	白	告警输入，输入告警信号，连接声控开关等设备	6
ALARM_IN2	紫		7
ALARM_IN3	橙		8
ALARM_IN4	棕		9
ALARM_IN_GND	绿	告警输入接地	10
ALARM_OUT 1A	黑/白	告警输出，输出告警信号，端子不分正负。连接报警灯等设备。	11
ALARM_OUT 1B	红/白		12
ALARM_OUT 2A	粉红		13
ALARM_OUT 2B	棕/白		14
AC24V1	红	电源，连接AC24V电源	-
PGND	黄绿	保护接地	-
AC24V2	黑	电源，连接AC24V电源	-
CVBS	-	视频输出，本地视频输出符合视频信号	-

【说明】 1)不同型号线缆规格有区别，请用户根据线缆数量参照上表进行识别。

2)电源AC 24V和电源接地，在电源线标签上有标示。

四 设备安装

1. 安装注意事项

- 确认安装地点有容纳本产品及其安装结构件的足够空间。
- 请确保安装摄像机的墙面、横杆等的承受能力必须能支撑摄像机及其安装结构件重量的 8 倍。
- 没有限高通行的路段，建议摄像机安装高度不低于 5 米，减少摄像机被碰擦的风险。
- 防止设备掉落，安装摄像机时必须安装安全绳。
- 施工期间禁止人员在摄像机下方 2 米内活动，并请配戴好安全帽等防护装备。

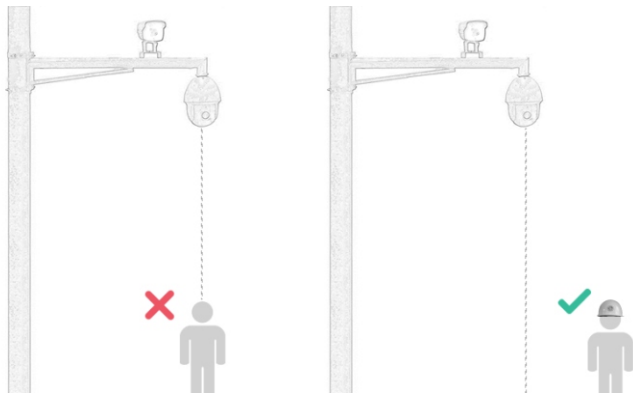

- 3) 在转接件螺纹处缠上生料带，将转接件旋紧到安装支架上，锁紧支架上的销钉，并确认转接件上防脱螺钉处于非锁紧状态；

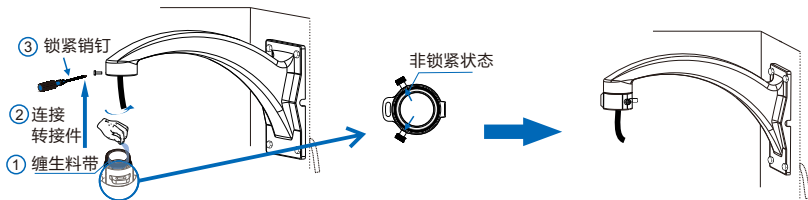

- 4) 取出安全绳，将一端预先挂扣在转接件的挂耳上；

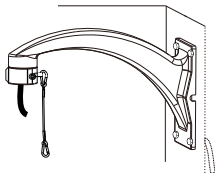

- 5) 将支架上的安全绳另一端挂扣到球机上，线缆穿过上球罩；球机安装柄的 D 字直边对准转接件上的标签后，将球机上推进转接件底部并旋转 180° 至黄色标签对齐，此时球机已固定；

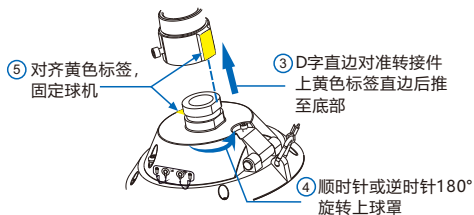
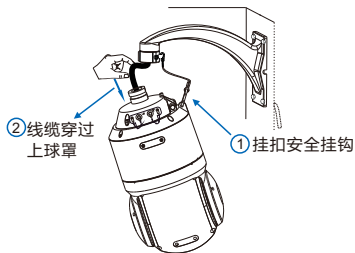

6) 锁紧转接件上的两颗防脱螺钉；

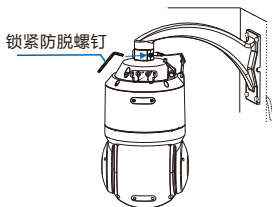

7) 拧开上球罩上两颗固定螺钉，打开上球罩，并将挂扣在上球罩上的安全绳挂钩小孔端挂扣在上球罩凸起的螺钉上；

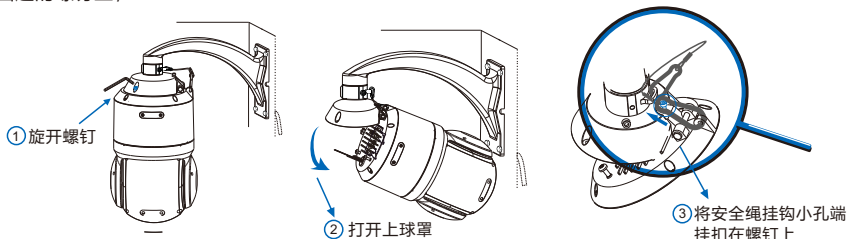

8) 按照球罩内所贴标签连接线缆，线缆连接参见尾线说明，连接完成后检查并整理各类线缆，线缆接口处用绝缘胶布缠绕牢固，务必将线缆整理好并用束带捆绑住，束带穿过束带固定件并拉紧束带；

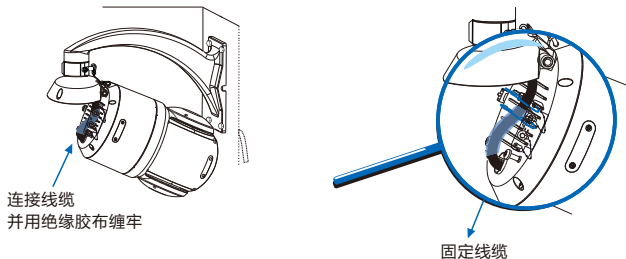

9) 摘下挂扣在上球罩螺钉上的安全绳，盖扣上球罩并拧紧上球罩上两颗固定螺钉；

- 10) 根据需要安装的天线类型，拧下对应标志一侧的防水帽螺母，将天线拧到螺钉上并拧紧，调整天线朝向上方；



- 11) 安装完成后，撕掉胶带及镜头、红外灯塑料保护膜，设备上电。

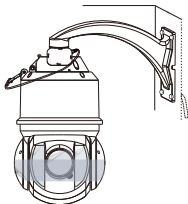

吊装

装配转接件及球机步骤参照壁装支架。

- 1) 将线缆从支架穿出，线缆请留出足够长度，以便连接到球机内线缆（推荐预留 20cm~30cm）；
- 2) 根据安装贴纸在墙面打好孔并塞入膨胀螺钉，将支架底座的孔对准墙面上的孔，放入螺钉，锁紧。

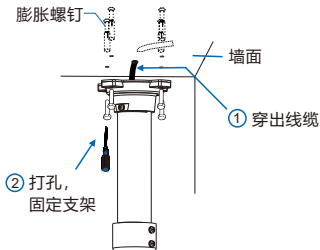

墙角支架安装

装配转接件及球机步骤参照壁装支架。

- 1) 将线缆从支架穿出，线缆请留出足够长度，以便连接到球机内线缆（推荐预留 20cm~30cm）；
- 2) 根据墙角装支架的安装孔位为模板，在墙壁上画出安装孔位置，打出安装孔，并塞入膨胀螺钉，固定墙角装支架；
- 3) 将壁装支架底座的孔对准墙角装支架上的孔，放入螺钉，锁紧。

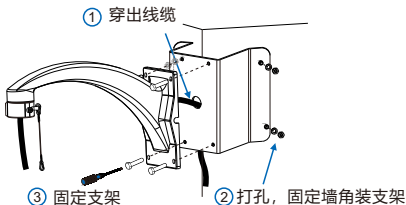

抱柱支架安装

装配转接件及球机步骤参照壁装支架。

- 1) 旋开抱柱支架卡箍；
- 2) 将线缆从支架穿出，线缆请留出足够长度，以便连接到球机内线缆（推荐预留 20cm~30cm）；
- 3) 将抱柱支架固定到安装柱上，拧紧卡箍固定支架；
- 4) 将壁装支架底座的孔对准抱柱支架上的孔，放入螺钉，锁紧。

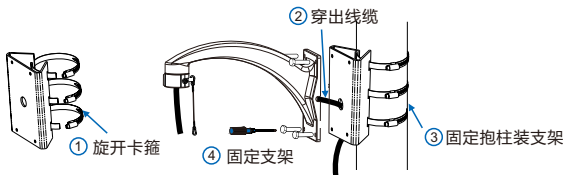

自制支架安装

用户可自制带销钉（至少 2 个）的支架安装摄像机，本手册以横杆为例。

- 1) 准备已经焊接好安装接口的横杆，距安装接口 10mm~13mm 处须安装有至少 2 个销钉；

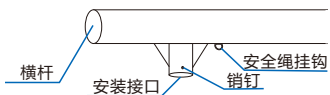

2) 将线缆从支架穿出，线缆请留出足够长度，以便连接到球机内线缆（推荐预留 20cm~30cm）；

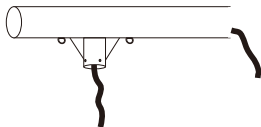

3) 取出安全绳，将安全绳挂钩一端预先挂扣在横杆挂钩上；

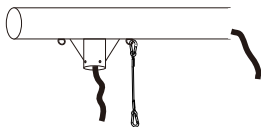

4) 球机安装步骤参照壁装支架安装。



3. 修改设备 IP

点击**修改网络参数**，在弹出的界面中配置网络参数。静态分配 IP 地址时，请选择自定义地址，填写以太网参数。修改参数配置，需要填写管理员用户名（admin）及激活设备时设置的密码。完成 IP 配置后，设备将自动重启。

4. 登录设备

1) 在 IPCSearch 中双击设备或点击设备登录，输入用户名和密码，登录 Web 客户端；



2) 登录成功后，根据提示下载并安装视频插件；

3) 进入客户端后，便可直接浏览图像。

【说明】不同型号的设备，浏览界面略有差异，请以实际界面为准。更多客户端操作说明请参考客户端帮助文档。

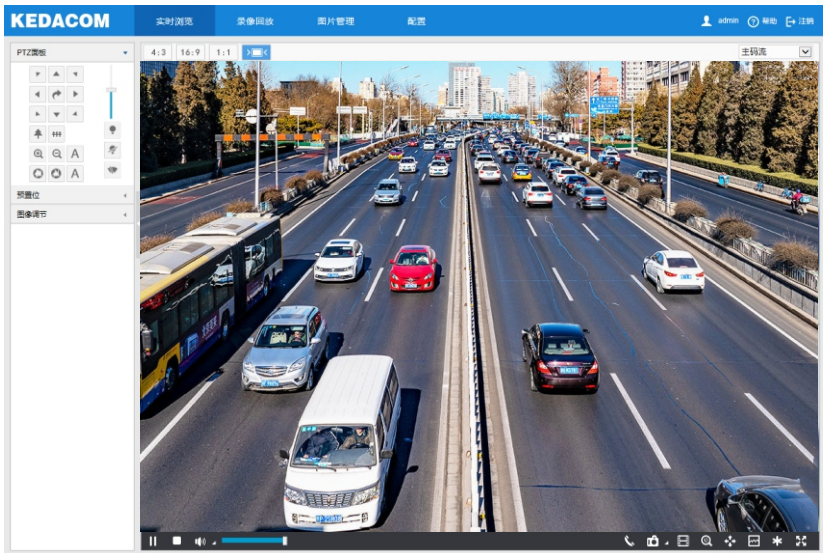

六 快速配置

1. 架设要求

安装时，应确保摄像机的架设符合下述要求：

- 摄像机高度应为4m~7m。若架设场景中有较多公交车、卡车等大型车辆通过，建议架设高度在6m以上。
- 摄像机与车辆行驶方向的水平夹角不得大于10°。
- 摄像机俯仰角度应为 10°~15°，推荐俯仰角度为13°。

2. 预置位配置

进入**智能展示>智能配置>预置位配置**界面，点击**安装示意图**，参考安装示意图进行安装配置，步骤如下：

- 1) 安装检查。根据实际的安装环境，并参考架设参数表（详见附件一），选择适宜的安装高度安装摄像机。安装完成后，通过PTZ面板调整摄像机，将摄像机调整至合适的监控位置；

【注意】安装时，可适当调整摄像机的安装高度和角度，以确保摄像机视野中心对准重点抓拍区域。摄像机不得倾斜，需确保画面中人员姿态端正。

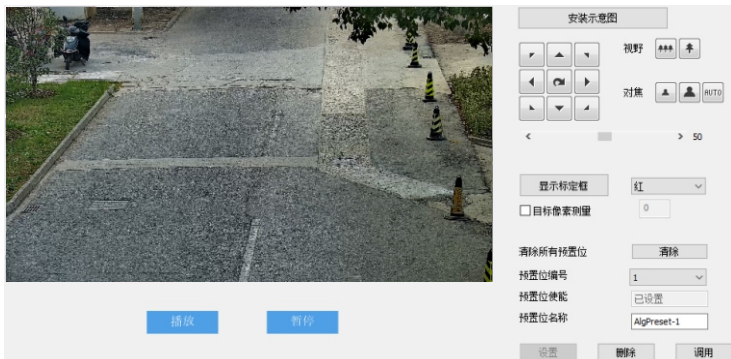

The screenshot displays the camera configuration interface. On the left is a live video feed of a road scene with a motorcycle and traffic cones. On the right is a control panel titled "安装示意图" (Installation Diagram). The panel includes a PTZ control grid with buttons for pan, tilt, and zoom, a "视野" (Field of View) control with a "###" icon, and a "对焦" (Focus) control with "▲" and "▼" icons and a "AUTO" button. Below these is a zoom slider set to 50. Further down, there are controls for "显示标定框" (Display Calibration Box) set to "红" (Red), an "目标像素测量" (Target Pixel Measurement) input set to 0, and a "清除所有预置位" (Clear All Presets) button. At the bottom, there are fields for "预置位编号" (Preset ID) set to 1, "预置位使能" (Preset Enable) set to "已设置" (Set), and "预置位名称" (Preset Name) set to "AlgPreset-1". At the very bottom are "设置" (Settings), "删除" (Delete), and "调用" (Call) buttons.

2) 视野调节。支持标定框调节和像素调节两种方式调节视野。调节完成后，点击**保存**，使设置生效。

标定框调节

- 进入**智能展示>智能配置>预置位配置**界面，选择标定框颜色，点击**显示标定框**，在画面中出现所选颜色的标定框；
- 将50cm×50cm的标定纸板（或车牌）置于画面中央，正对镜头；
- 点击**拉远**或**拉近**按钮，调节视野，改变标定纸板（或车牌）在画面中的大小；标定纸板与较小的标定框重合时，即为最大监控场景；标定纸板与较大标定框重合时，即为最小监控场景。



像素调节

- 进入**智能展示>智能配置>预置位配置**界面，勾选**目标像素测量**，可显示画面中人员的瞳孔间距或车辆的车牌宽度；
- 使人员或车辆处于画面中央；
- 点击**拉远**或**拉近**按钮，调节视野，改变人脸或车牌在画面中的大小，确保瞳孔间距、车牌宽度不低于规定的最小值即可。

【说明】人员卡口系列高清智能球型网络摄像机仅有像素调节一种方式。通过视野按钮改变画面中人脸的大小来确定瞳孔间距，完成视野调节。

摄像机镜头像素	200W	400W
车牌宽度 (像素)	>100	>120
瞳孔间距 (像素)	>20	>25



播放

暂停

安装示意图

视野

对焦

< >

显示标定框

目标像素测量

清除所有预置位

预置位编号

预置位使能

预置位名称

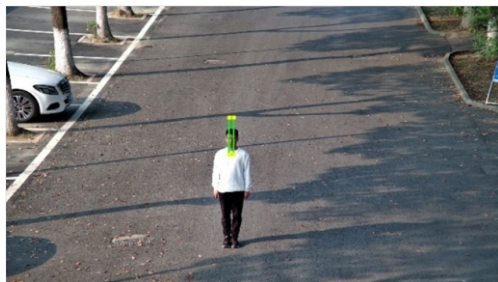

播放

暂停

安装示意图

视野

对焦

< >

显示标定框

目标像素测量

清除所有预置位

预置位编号

预置位使能

预置位名称

3) 对焦。摄像机聚焦模式默认为自动聚焦，当且仅当自动聚焦无法获得清晰的图像时，才需进行手动对焦。

【说明】 分辨率大于200W像素的摄像机，需手动绘制聚焦区域。可在预绘制区域中布置人员或放置纹理丰富的物体，以提高对焦精度。

- 1) 进入**配置>摄像机>图像>聚焦**，在聚焦区域下拉框中选择**自定义**，点击**开始绘制**，在画面底部位置绘制重点聚焦区域，绘制完成后，点击**停止绘制**；
- 2) 再点击**设置**，进行自动聚焦。

图像效果



4) 预置位设置。完成以上步骤后，在预置位编号下拉框中选择编号，填写预置位名称，点击**设置**，完成预置位配置；点击**调用**，当前预置位生效并进行智能分析。

【说明】 最多可设置8个预置位。

【注意】 点击**调用**后，当前预置位生效并进行智能分析，同时锁定预置位状态。若在其他界面调节云台或视野，5分钟后摄像机自动恢复到锁定的预置位状态。

3. 标定配置

摄像机预置位配置完成后，才可进行标定配置。若摄像机的高度、俯仰角、焦距等参数发生变化，需重新进行标定配置。

【说明】 人员卡口系列高清智能球型网络摄像机不支持近景框和远景框的标定。

1) 进入**智能展示>智能配置>标定配置**界面，在预置位下拉框中选择预置位；

2) 标定。摄像机主要用于抓拍车辆时，需参照车牌进行标定；

a) 进入**智能展示>智能配置>标定配置**界面，勾选**启用近景远景框**。当车辆的车牌处于画面中央时，点击**暂停**，调整远景框的大小和位置，使远景框与车牌宽度相同；

【说明】 点击选中框体，拖动框体四角的黄色端点，可调整相应框体的长和宽；长按边框，拖动相应框体，可将其调整到合适的位置。

b) 点击**播放**，当车辆的车牌靠近监控画面的下沿时，点击**暂停**，调整近景框的大小和位置，使近景框与车牌宽度相同。

【说明】 标定过程中，不可进行视野调节，即不可使用拉近、拉远按钮。



- 3) 优选区域配置。未启用优选区域时，摄像机默认为全画面选优；启用后，当目标经过设置的优选区域后，摄像机将优先输出该区域内抓拍的最佳快照。

【说明】优选区域配置适用于人脸和机动车抓拍。

实际场景中，尤其是夜晚补光灯仅能覆盖部分区域的情况下，需进行优选区域配置，步骤如下：

- 进入**智能展示>智能配置>标定配置**界面，勾选**启用优选区域**，显示优选区域，默认为画面从上至下1/2~3/4处。
- 点击优选区域框，拖动框体四角的黄色端点，可调整优选区域的长和宽；长按蓝色边框，拖动优选区域框体，可将其调整到合适的位置。



- 4) 点击**保存**，参数设置即可生效。

附录一 架设参数表

以下为摄像机按推荐俯仰角度架设，即俯仰角为13°时的架设参考数据。

【说明】最佳监控距离，指监控画面中下部与摄像机的水平距离。

200W像素			
架设高度	架设俯仰角	最佳监控距离	监控宽度
4m	13°	8~11m	5m
5m	13°	12~15m	5m
6m	13°	16~19m	5m
7m	13°	20~23m	5m
400W像素			
架设高度	架设俯仰角	最佳监控距离	监控宽度
4m	13°	7~11m	6m
5m	13°	11~15m	6m
6m	13°	15~19m	6m
7m	13°	18.5~23.5m	6m

【说明】云台摄像机角度、方向可变，更为灵活，监控范围更广。

附录二

防水

- 室外安装推荐使用支架横臂有一定向上角度的壁装支架。
- 用户自选支架安装推荐使用接口为内螺纹的支架，同时须确保支架的防水性能；用户自选支架安装若选用外螺纹支架，须确保支架与球机连接的转接器件的防水性能。
- 安装时螺纹口需缠绕生料带，并确保螺纹密封；对准螺纹，不能出现明显偏位及滑丝。
- 球机透明球罩上的密封胶圈必须安装，防止水蒸气及灰尘进入设备。

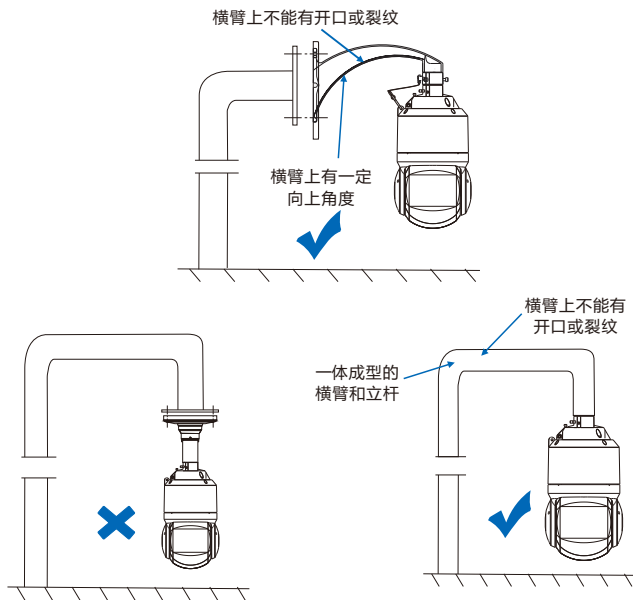

防静电、防干扰、防雷、防浪涌

- IPC 安装不进行接地可能会因为静电造成电子器件损坏。
- 在雷电多发地区，需要对 IPC 进行就近接地，释放雷击等高能量，防止 IPC 损坏。
- 在电压不稳地区，需要对 IPC 进行接地，释放浪涌等高能量，防止 IPC 电源烧坏。
- IPC 安装防雷接地线不能替代安全接地线。在采用接地不良的立杆，如木杆、水泥杆，需要安装安全接地线，泄放漏电流以确保 IPC 或立杆不引起安全事故。
- IPC 安装防雷接地线不能借用附近的其他电子设备接地线入大地，必须单独接地。

【水泥杆接地】

水泥杆方式需要配置钢管护套用于接地线穿管，如图所示，球机接地线从钢管内部穿过接地。控制中心本地进行规范接地即可。

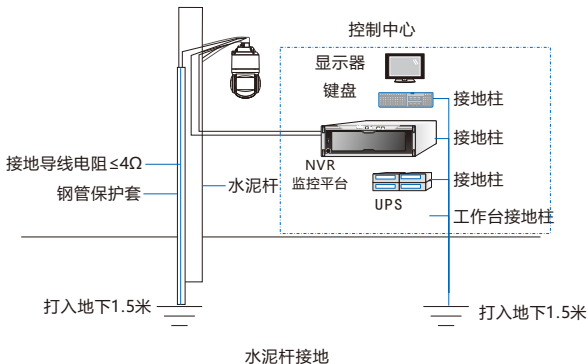

【金属杆接地】

金属杆方式采取 PVC 管穿接地线。没有安装避雷针的金属立杆，采用接地线（穿 PVC 管套）靠近金属杆的位置固定后实施接地，如图所示。

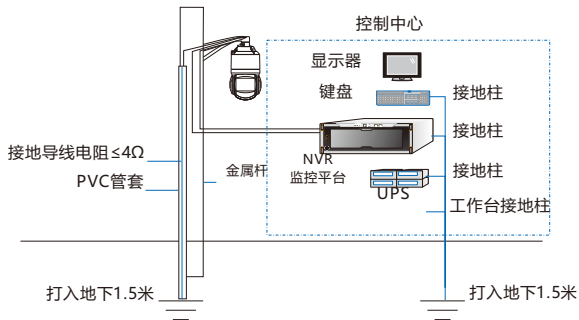

金属杆接地(无避雷针)

安装了避雷针的金属杆，采用金属杆内穿接地线（穿 PVC 管）的方式接地，且 PVC 管需要与金属杆内避保持尽量大的绝缘距离，如图所示。

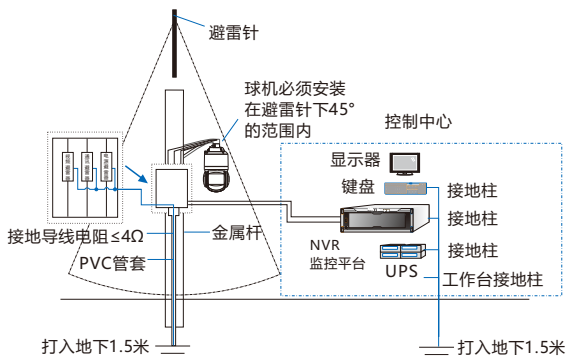

金属杆接地(有避雷针)

【注意】 如果 IPC 传输过程中使用了光端机或者防雷器等中间件，需确保中间件接地良好，同时需确保 IPC 的连接线缆通过中间件也能接地良好。

附录三 AC 24V 线径与传输距离关系表

当线径大小一定, AC 24V 电压损耗率低于 10% 时, 不同传输功率推荐的最大传输距离。(对于 AC 24V 交流供电设备, 其最大允许电压损耗率为 10%。下面表格中所用线缆均为铜线, 铜的电阻率为 $\rho = 0.0175\Omega \cdot \text{mm}^2/\text{m}$)

线径mm 距离mm (feet) 功率W	0.8 (20AWG)	1.0(18AWG)	1.25(16AWG)	2.0(12AWG)
5	122 (401)	194 (636)	307 (1008)	781 (2562)
10	61 (201)	97 (318)	154 (504)	391 (1281)
15	41 (134)	65 (212)	102 (336)	260 (854)
20	31 (100)	48 (159)	77 (252)	195 (641)
25	24 (80)	39 (127)	61 (202)	156 (512)
30	20 (67)	32 (106)	51 (168)	130 (427)
35	17 (57)	28 (91)	44 (144)	112 (366)
40	15 (50)	24 (79)	38 (126)	98 (320)
45	14 (45)	22 (71)	34 (112)	87 (285)
50	12 (40)	19 (64)	31 (101)	78 (256)
55	11 (36)	18 (58)	28 (92)	71 (233)
60	10 (33)	16 (53)	26 (84)	65 (214)
65	9 (31)	15 (49)	24 (78)	60 (197)
70	9 (29)	14 (45)	22 (72)	56 (183)
75	8 (27)	13 (42)	20 (67)	52 (171)
80	8 (25)	12 (40)	19 (63)	49 (160)
85	7 (23)	11 (37)	18 (59)	46 (151)
90	7 (22)	11 (35)	17 (56)	43 (142)
95	6 (21)	10 (33)	16 (53)	41 (135)
100	6 (20)	10 (32)	15 (50)	39 (128)

【备注】 线径要求适用于单根、实心、圆形的铜线, 多股绞线的电缆 AWG 值是由所有线的总横截面积决定。

保修说明

本保修卡适用于您购买的本公司系列产品。

- 1.免费保修期一年（仅限中国大陆地区，中国大陆以外地区请参考英文说明）。
- 2.凡保修期内，由于本产品自身引起的故障，请与公司售后服务部联系。
- 3.保修时我们将使用您的保修卡信息，请认真填写。
- 4.以下情况，属于有偿保修范围：
 - 人为原因造成的设备故障
 - 因使用环境不符合本产品要求造成的故障
 - 因不可抗力造成的产品损坏
 - 无保修卡
 - 已过免费保修期

用户信息

用户名称：

详细地址：

传真：

电话：

邮箱：

邮编：

产品名称：

产品型号：

购买日期：

I. Preface

Thank you for purchasing our product. If there are any questions, or requests, please do not hesitate to contact us.

The intention of writing this Guide is to ensure that user can use the product correctly to avoid danger or property loss. Please read this Guide carefully before using, and keep it properly for future reference. If the product cannot work normally or is damaged because the user does not follow the safety instructions, we shall not assume any responsibility. Your cooperation will be highly appreciated.

II. Safety Instruction

1. Power Supply

- During installing and using the device, please follow local electrical safety regulations strictly.
- Please use power supply in the safe voltage range of our product. Make sure if the power supply is correct before running the device.
- Please install an easy-to-use breaker during installation and wiring in case it is necessary to make an emergency break.
- Please prevent the power cord from being trampled or pressed especially the plug, socket and the connecting part led out from the device.
- Please connect cables of power, alarm, audio and RS-485 with the power off. Hot-line wiring is not allowed.

2. Working Environment

- Do not focus the camera lens on strong light such as the sun or incandescent lamp; otherwise the strong light will cause overexposure or light leak (not camera malfunction), which may shorten camera lifetime.
- Please transport, use and store the device within defined humidity and temperature ranges.
- Do not expose it in damp, dusty, extremely hot or cold places or places with intense electromagnetic radiation or with unstable lighting.
- Keep the camera away from water or any liquid to avoid damage to internal components.
- To avoid heat accumulation, please do not block the ventilation around the device.
- While shipping the camera, pack it in the factory packing or use materials with equivalent quality.
- When shipping, storing and installing the device, try to prevent it from damages caused by pressure, violent vibration and shaking.
- Please do not install the device on unstable bracket, wall or roof; otherwise it may damage people and the device.

Working Environment	
Voltage	AC24V±10%, 50~60Hz
Condition	Waterproof, lightning protection, anti-interference
Working Temperature	-40°C~+70°C
Humidity	10%~95% (Relative, non-condensing)

3. Daily Maintenance

- Do not touch the heat component of the device directly to avoid empyrosis.
- When the glass surface of the lens is contaminated by dust or grease, use cotton cloth or lens clean cloth to wipe it off. When it is hard to clean, dip some lens cleanser and wipe gently and rotate outward from the middle until it is clean. Never apply any organic solvent with ethanol or benzene to clean the lens and housing.
- Do not disassemble or repair the device in any way by yourself. We shall not assume any responsibility for problems caused by unauthorized operations.
- If the product does not work properly, please contact your dealer or the nearest service center.

4. Special Statement

- The product appearance is subject to the actual device and picture in this Guide is for reference only.
- Every effort has been made to ensure the accuracy and validity of this Guide. Any update of this Guide caused by version upgrade is subject to change without notice.
- This Guide is made for multiple models but due to limited space, it will not illustrate all models one by one. Please refer to it according to the actual products you are using.
- This device can be used after being activated through IPCSearch (download it from our website: <https://www.kedacom.com/cn/softtools/index.jhtml>). During activation please fill a valid email address for finding back the password.
- To ensure the safety of device on internet, it is strongly recommended that you set a strong password which is composed of at least 2 kinds of the following, digits, case-sensitive letters or specific symbols, and whose length ranges from 8 to 16 bits. Please modify the password periodically and once every 3 months is recommended. If the device is used in highly risky environment, suggest modifying the password monthly or weekly. Please keep your user name and password safe.
- For the latest files, please download from our website www.kedacom.com.

III Appearance

Dimensions

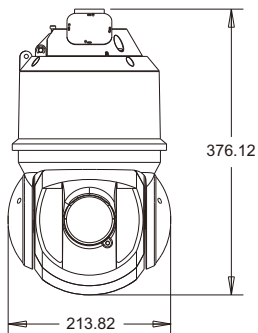

IR Type

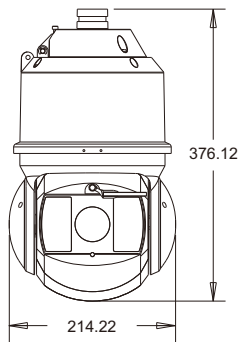

IR Type with Wiper

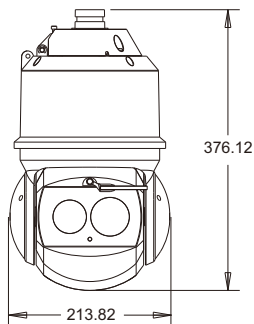

Laser Type

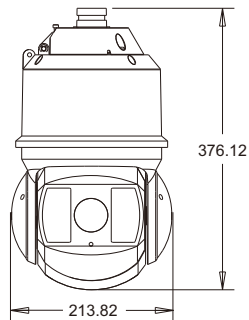

IR Type

Unit: mm

Net weight: 6.1 KG Max

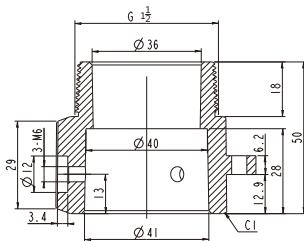

Size of connector

Unit: mm

Components

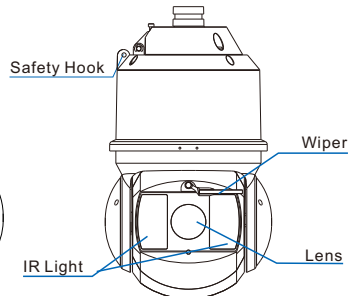
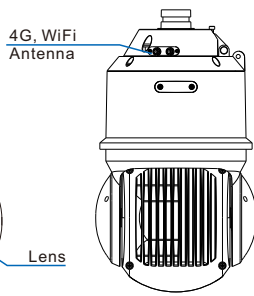
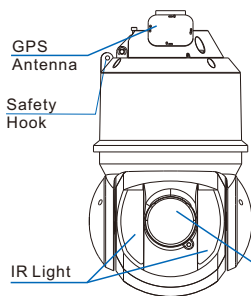

IR Type

IR Type with Wiper

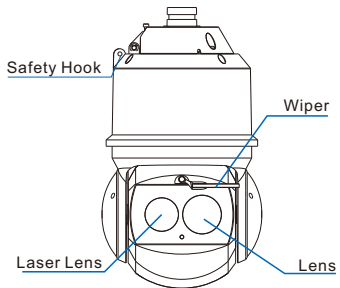

Laser Type

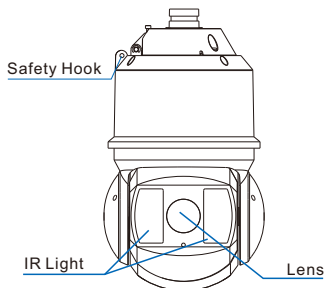

IR Type

[Note]: The components of different sub-models may differ. The GPS antenna, 4G antenna and WiFi antenna are optional parts. Please subject to the actual models.

Tail Wire

Tail Wire 1

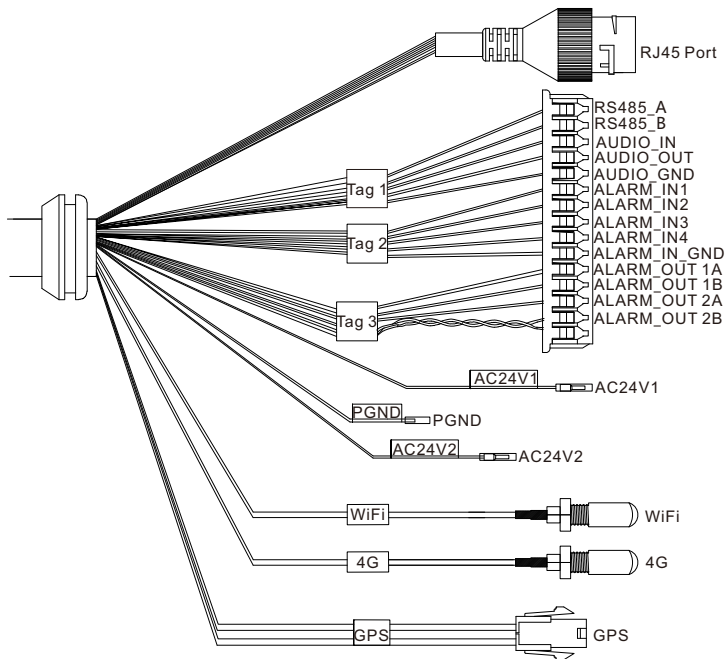

Tag	Color	Function	No.
RJ45 Port	-	RJ45 port, connect to network device, support adaptive 10/100Mbps	-
RS485_A	Black	RS-485 serial port, connect to external devices for control such as controlling a third-party device	1
RS485_B	Red		2
AUDIO_IN	Gray	Audio input, inputting audio signal; connect to sound pick-up	3
AUDIO GND	Yellow	Audio grounding port	4
AUDIO_OUT	Blue	Audio output port, for outputting audio signal; connect to loudspeaker	5
ALARM_IN1	White	Alarm input port, for inputting alarm signal; connect to voice-operated switch and etc.	6
ALARM_IN2	Purple		7
ALARM_IN3	Orange		8
ALARM_IN4	Brown		9
ALARM_IN_GND	Green	Alarm input grounding port	10
ALARM_OUT 1A	Black/White	Alarm output port, for outputting alarm signal, regardless of positive or negative poles; connect to alarm light	11
ALARM_OUT 1B	Red/White		12
ALARM_OUT 2A	Pink		13
ALARM_OUT 2B	Brown/White		14
AC24V1	Red	Power supply, connect to AC24V	-
PNGD	Yellow/Green	Protective grounding	-
AC24V2	Black	Power supply, connect to AC24V	-
WiFi	-	WiFi, connect to WiFi antenna	-
4G	-	4G, connect to 4G antenna	-
GPS	-	GPS, connect to GPS antenna	-

Tail Wire 2

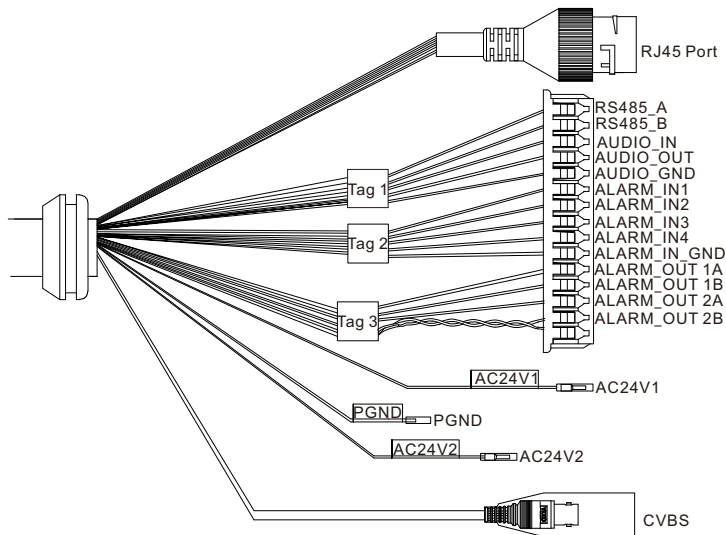

Tag	Color	Function	No.
RJ45 Port	-	RJ45 port, connect to network device, support adaptive 10/100Mbps	-
RS485_A	Black	RS-485 serial port, connect to external devices for control such as controlling a third-party device	1
RS485_B	Red		2
AUDIO_IN	Gray	Audio input, inputting audio signal; connect to sound pick-up	3
AUDIO_GND	Yellow	Audio grounding port	4
AUDIO_OUT	Blue	Audio output port, for outputting audio signal; connect to loudspeaker	5
ALARM_IN1	White	Alarm input port, for inputting alarm signal; connect to voice-operated switch and etc.	6
ALARM_IN2	Purple		7
ALARM_IN3	Orange		8
ALARM_IN4	Brown		9
ALARM_IN_GND	Green	Alarm input grounding port	10
ALARM_OUT 1A	Black/White	Alarm output port, for outputting alarm signal, regardless of positive or negative poles; connect to alarm light	11
ALARM_OUT 1B	Red/White		12
ALARM_OUT 2A	Pink		13
ALARM_OUT 2B	Brown/White		14
AC24V1	Red	Power supply, connect to AC24V	-
PNGD	Yellow/Green	Protective grounding	-
AC24V2	Black	Power supply, connect to AC24V	-
CVBS	-	Video output, local video output composite video signal	-

[Note]:

- 1) The wire interface of different models may differ. Please subject to the actual wires on the device and refer to the table above to identify the wires;
- 2) The AC24V power supply and its grounding are marked on the tag of the power supply wire.

IV. Installation

1. Safety Instructions

- Make sure there is enough space for mounting the camera and its accessories.
- Make sure the wall or cross-bar can bear the weight as heavy as 8 times of the total weight of the camera and the accessories.
- On roads without height limits, the suggested installation height of the camera should be higher than 5m so as to reduce friction to the camera.
- To prevent the device from dropping, the camera must be installed with a safety hook during installation.
- During installation, no man shall be allowed to move around in 2m under the camera, and all men should wear a safety helmet.

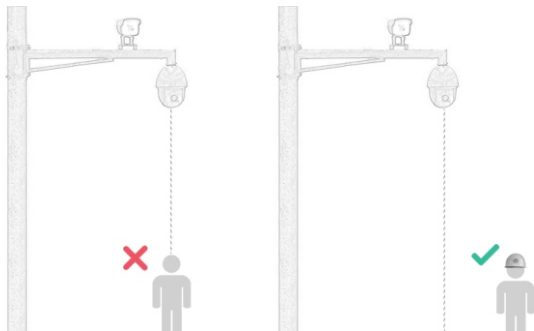

2. Install Storage Card

Open the cover on the dome and insert the storage card, max supporting 128G.

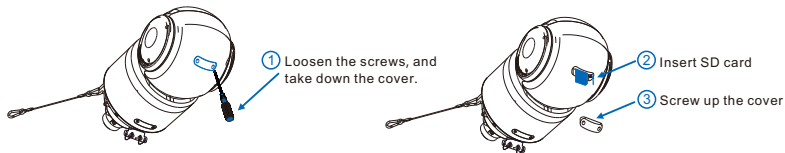

[Note]: The SD card slot location shall subject to the tags on actual models.

3. Installation Method

The camera supports wall bracket mount, pendent mount, corner bracket mount, pillar bracket mount and self-made bracket mount.

[Note]: All brackets are optional.

Wall Bracket Mount

- 1) Thread the wires through the bracket and reserve a certain length for connecting with the internal wire of the dome camera (20 cm to 30 cm recommended).
- 2) Drill holes on the wall according to the installation sticker, insert expansion screws, align the holes on the bracket to the holes on the wall, insert screws and tighten up.

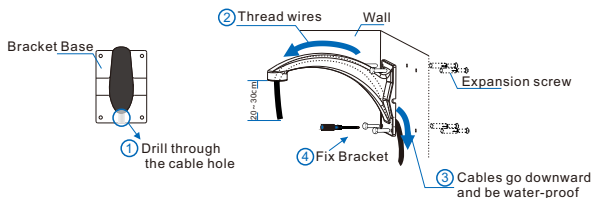

Cables go through the bracket base

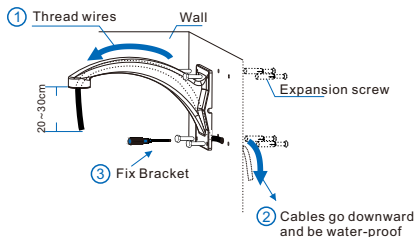

Cables go through the wall

- 3) Bind thread seal tape around the screw thread part of the connector, screw up the connector onto the bracket and tighten the pins on the bracket. Make sure that the anti-off screw on the connector is loose.

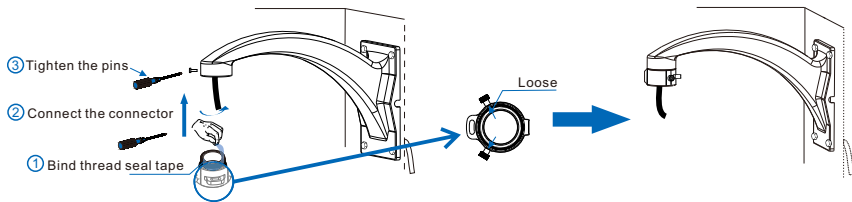

4) Take out the hook and hang it on the hanger of the connector.

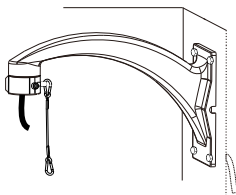

5) Hang the safety hook and thread the wires through the upper housing. Align the straight side of D-shaped head to connector sticker, then push the head till the end, and rotate 180° and align to the yellow sticker, then the dome camera is fixed.

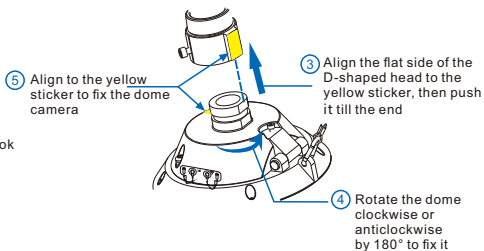
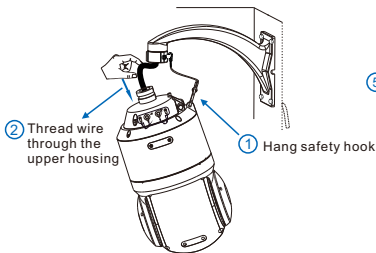

6) Tighten 2 anti-off screws.

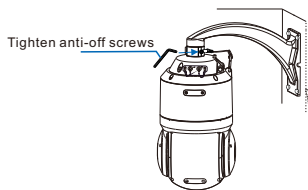

7) Twist off the 2 positioning screws on the upper housing to open it. Hang the hole end of the safety hook on the convex screw on the housing.

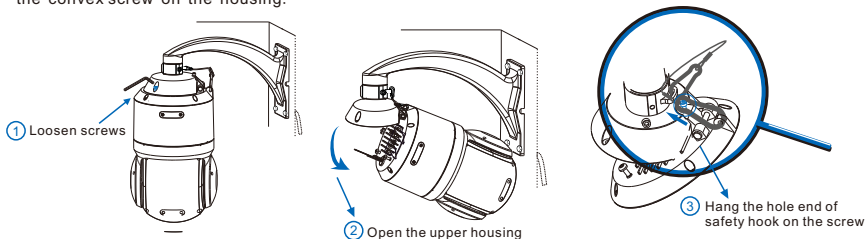

8) Connect cables as the sticker inside the dome camera indicates, and detailed diagram can be referred to in the Appendix. Afterwards, examine and sort out the cables, tighten the connecting parts with insulating tape. Make sure that cables are well sorted and bound. Thread the bound cables through the positioning part and pull them tight.

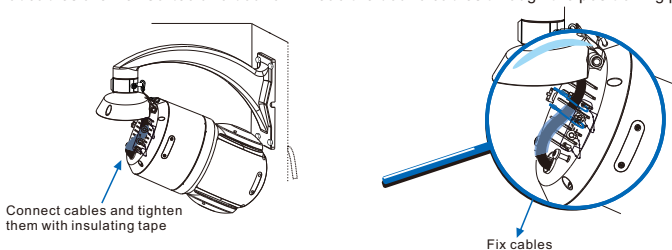

9) Pick off the safety hook hanged on the screw on the upper dome. Cover the dome and tighten the 2 positioning screws on it.

- 10) According to the antenna type to be installed, unscrew the corresponding waterproof screw nut, screw up the antenna onto the screw and make it tight, and adjust the antenna upward.

- ① Unscrew the waterproof screw nut

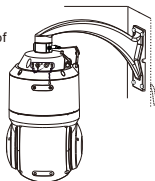

- ② Tighten the antenna and adjust its direction

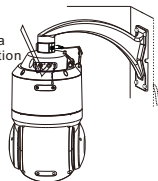

- 11) After finish installation, peel off the adhesive tape and the plastic protective film on the lens and the IR lamp, and power on the device.



Pendent Bracket Mount

Please refer to the Wall Bracket Mount for the installation of the connector and the dome camera.

- 1) Thread the wires through the bracket and reserve a certain length for connecting with the internal wire of the dome camera (20 cm to 30 cm recommended).
- 2) Drill holes on the wall according to the installation sticker, insert expansion screws, align the holes on the bracket to the holes on the wall, insert screws and tighten up.

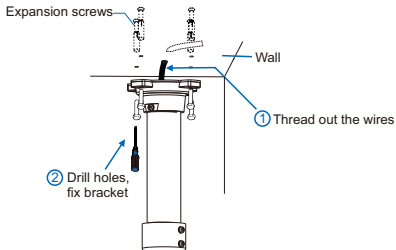

Corner Bracket Mount

Please refer to the Wall Bracket Mount for the installation of the connector and the dome camera.

- 1) Thread the wires through the bracket and reserve a certain length for connecting with the internal wire of the dome camera (20 cm to 30 cm recommended).
- 2) Draw and drill holes on the wall according to the holes on the corner bracket, insert expansion screws and fix the corner bracket.
- 3) Align the holes on the wall bracket base to the holes on the corner bracket, insert screws and tighten them up.

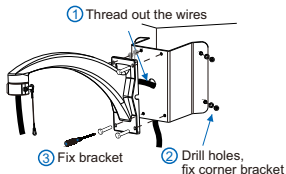

Pillar Bracket Mount

Please refer to the Wall Bracket Mount for the installation of the connector and the dome camera.

- 1) Unscrew the clamp on the pillar bracket.
- 2) Thread the wires through the bracket and reserve a certain length for connecting with the internal wire of the dome camera (20 cm to 30 cm recommended).
- 3) Fix the pillar bracket onto the mounting pillar, tighten the clamp and fix the bracket;
- 4) Align the holes on the wall bracket base to the holes on the pillar bracket, insert screws and tighten them up.

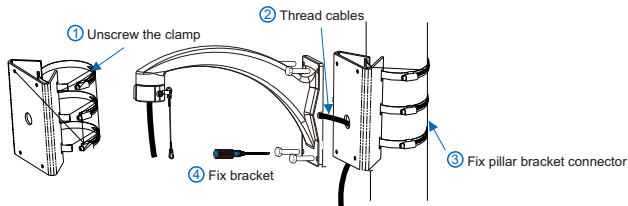

Self-Made Bracket Mount

User can install the camera with self-made bracket with at least 2 pins. This guide will take the cross-bar bracket as an example.

- 1) Get a welded cross-bar ready and there must be at least 2 pins mounted 10mm~13mm from the mounting port;

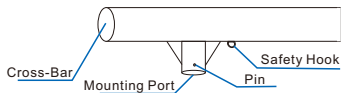

- 2) Thread the cables out from the bracket and reserve enough length for connecting to the cables in the dome camera (suggest reserving 20cm~30cm);

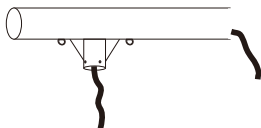

- 3) Take out the safety hook and hang one end of it onto the hook of the cross-bar;

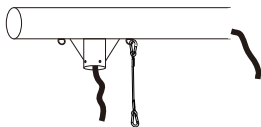

- 4) For the installation of dome camera, please refer to the steps of Wall Bracket Mount.

V. Login to the Device

1. Minimum system configuration and environment requirements:

- Processor: 3.3 GHz CORE®i3 series or other equivalent processors
- RAM Memory: 4GB or above
- Operating System: Windows 7 or higher versions
- Browser (32-bit): 360 browser, IE 11.0 and higher versions, Firefox (51.0 and lower versions), Google Chrome (41.0 and lower versions)
- DirectX : 9.0c

2. Device Activation

When using the device for the first time, run IPCSearch and it will search devices in LAN automatically and display the list of device IP address, gateway and etc. If the network provides DHCP service, DHCP server will assign IP for the camera automatically.

- Batch: Select the device and click "**Batch processing**". In the popup interface, set admin user's password and the email address to find back the password. Click "**Activate**" and wait for rebooting.
- Individual: Select the device from IPCSearch and right click to select "**Active**". Fill admin user name and password and the e-mail address to find back the password. Click "**Activate**" and wait for rebooting.
- Web client: the device can also be activated through the web client. Set PC and the device in the same network segment and login to the web. User can set admin password and password reset email on the interface and click "**Activate**".

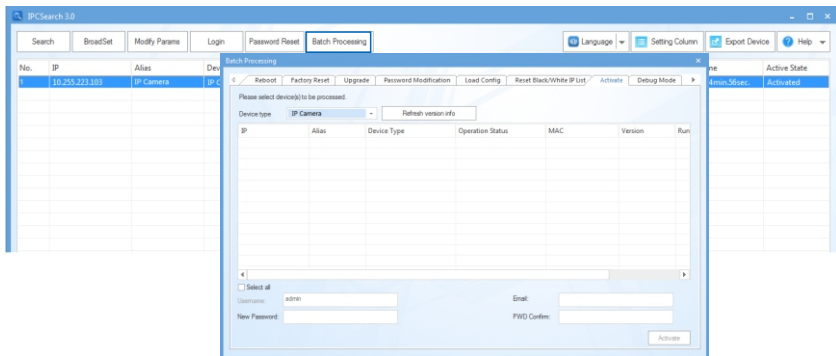

Login



Weak
Strong

Please choose a password with 8-16 characters. Your password must also contain two or more combinations of upper and lowercase letters, numbers, and symbols.

When admin's password gets lost, find it back through this email. Please sure this email address is safe and valid.

3. Modify Device IP Address

Click **"Modify Params"** and set the network parameters. When configuring a static IP for the camera, please check **"Custom device address (Close DHCP)"** and fill the Ethernet parameter. During the modification, the user name (admin) and the password set before activation should be entered. After configuration, the camera will reboot automatically.

4. Login to the Device

- 1) Double click the device in IPCSearch or click **"Login"**. Enter user name and password to login the web client.
- 2) After login, download and install the plug-in.
- 3) Re-login to the web client and view live video directly.

Login

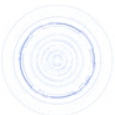

[Note]: Interface of different models may differ. Please subject to the actual products. Please refer to the *Help* file for detailed explanation.

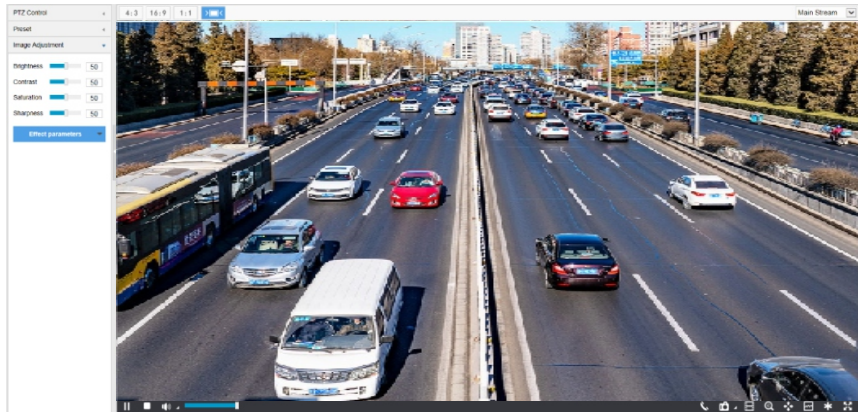

VI Quick Settings

1. Installation Requirements

Before installation, make sure the installation of camera meets the following requirements:

- The installation height of the camera should be in the range of 4 m to 7 m. If there are many buses and trucks passing through in the scene, recommend installing the camera over 6 m.
- The horizontal angle between the camera and the vehicle direction should not be larger than 10° .
- The camera angle of pitch should be in the range of 10° to 15° , and 13° is recommended.

2. Installation Configuration

Go to **Intelligent > Settings > Install**. Click "**Installation Diagram**" and configure according to the installation diagram, steps as follows:

- 1) Installation examination. Select proper installation height for the camera according to the actual environment and Appendix I: Reference of Installation Parameters. After finish installation, adjust the camera to proper angles through the PTZ control buttons on live view interface.

[Attention] During installation, you can adjust camera installation height and angles properly to make sure the camera lens is facing rightly to the key surveillance area. The camera cannot be slanted so as to make sure the person in the picture stands upright.

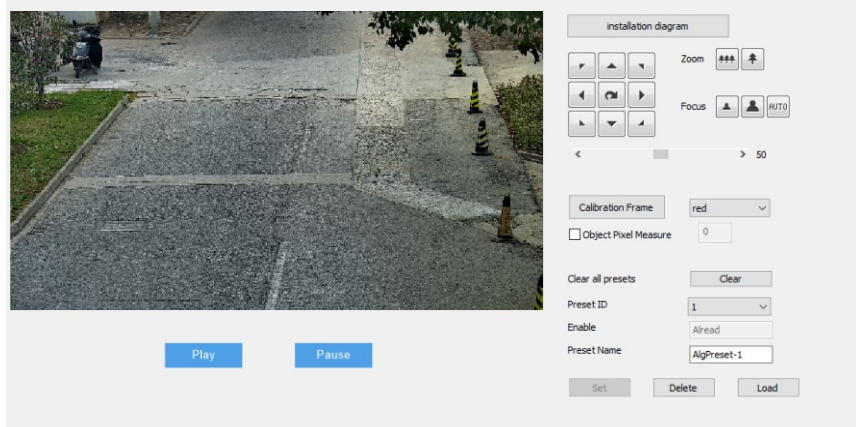

The screenshot shows the camera's live view interface. The main area displays a road scene with a motorcycle and traffic cones. Below the video are two blue buttons labeled "Play" and "Pause". To the right is a control panel titled "installation diagram". It includes PTZ controls: a "Zoom" section with left, up, and down arrows, and a "Focus" section with left, center, right, and up/down arrows, along with a "Focus" slider and a "50" value. Below these are "Calibration Frame" (set to "red"), "Object Pixel Measure" (checkbox), and "Clear all presets" (button). The "Preset ID" is set to "1", "Enable" is "Aired", and "Preset Name" is "AlgPreset-1". At the bottom are "Set", "Delete", and "Load" buttons.

- 2) Adjust camera field of view. There are 2 methods, calibration frame adjustment and pixel adjustment. After finishing adjustment, click **"Save"** to validate settings.

Calibration frame adjustment:

- Go to **Intelligent > Settings > Install**, select calibration frame color and click "Calibration Frame" to show the calibration frame in the selected color;
- Put the calibration board (or vehicle plate) sized 50 cm * 50 cm in the center of the image facing the lens;
- Click icons of **"Zoom in"** or **"Zoom out"** to adjust the field of view and change the size of the calibration board (or vehicle plate) in the image; when the calibration board coincides with the smaller frame, it is the maximum scene; when the calibration board coincides with the larger frame, it is the minimum scene.

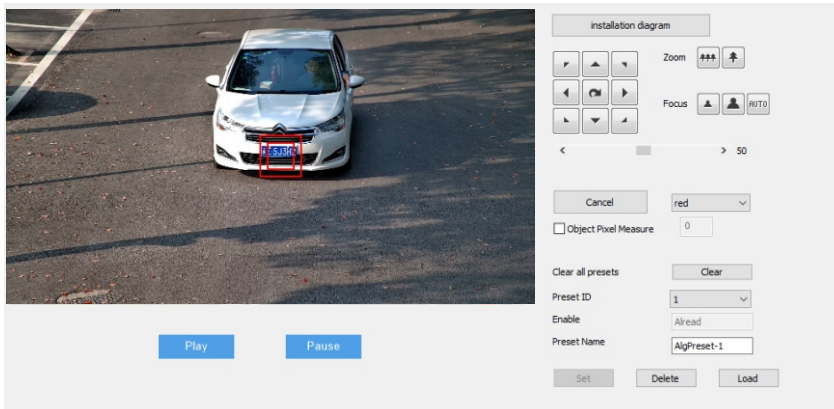

Pixel adjustment:

- Go to **Intelligent > Settings > Install**, select **"Object Pixel Measure"** to show the interpupillary distance (IPD) of the person or show the width of the vehicle plate in the image;
- Make the person or the vehicle in the center of the image;
- Click icons of **"Zoom in"** or **"Zoom out"** to adjust the field of view and change the size of human face or vehicle plate to ensure the IPD or the plate width is no less than the specified minimum value.

[Note]: IPC4X5-i4XX series have only one kind of method, i.e. pixel adjustment. Adjust the field of view to change the size of human face so as to determine the IPD and finish adjustment of field of view.

Camera Lens (pixel)	2.0 MP	4.0 MP
Plate Width (pixel)	> 100	> 120
IPD (pixel)	> 20	> 25



Play
Pause

installation diagram

Zoom

Focus

< > 50

Calibration Frame red

Object Pixel Measure 230

Clear all presets Clear

Preset ID 1

Enable Already

Preset Name AlgPreset-1

Set
Delete
Load



Play
Pause

installation diagram

Zoom

Focus

< > 50

Calibration Frame red

Object Pixel Measure 42

Clear all presets Clear

Preset ID 1

Enable Already

Preset Name AlgPreset-1

Set
Delete
Load

- 3) **Focusing.** The default focus mode of the camera is auto. Only when auto focusing cannot obtain clear images should user focus manually.

[Note]: When the camera resolution is above 2.0 MP, you need to edit the focus area manually. You can arrange a person or put a richly-textured object in the edit area so as to improve focus accuracy.

- 1) Go to **Settings > Camera > Image > Focus**, select **"Custom"** for Focus Area and click **"Edit"** to edit key focusing area at the bottom of the image. After finish editing, click **"Stop Editing"**.
- 2) Click **"Setting"** to focus automatically.

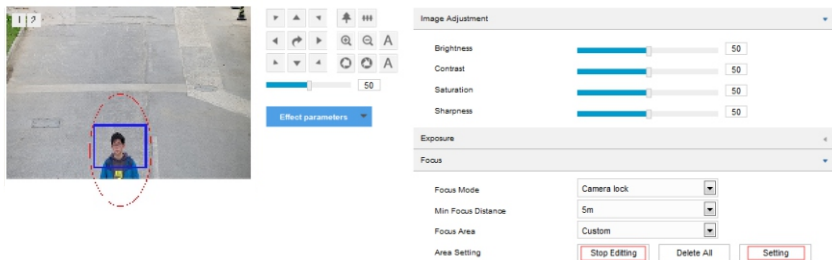

- 4) **Preset setting.** After finish the above steps, select a preset number from the dropdown list, enter preset name and click **"Save"** to finish preset setting; click **"Load"** to validate current preset and perform intelligent analysis.

[Note] It supports maximum 8 preset positions.

[Attention]: After click "Load", current preset takes effect and perform intelligent analysis and meanwhile its status is locked. If you adjust the PTZ or camera field of view on other interfaces, the camera will restore to locking status automatically in 5 minutes.

3. Calibration

After finishing installation and configuration of the camera, perform calibration settings. If the camera height, angle of pitch or focal length changes, user needs to calibrate again.

[Note] The intelligent speed dome camera for human checkpoint does not support “Near Far Box Flag” calibration.

- 1) Go to **Intelligent > Settings > Calibration** and select a preset number from the dropdown list.
- 2) Calibrate. When the camera is used to capture vehicle plates, calibrate by referring to the vehicle plate.
 - a) Go to **Intelligent > Settings > Calibration**, and select “**Enable NearFarBoxFlag**”. When the vehicle plate is in the center of the image, click “**Pause**”. Adjust the size and position of the “Far” box to make it the same width as that of the plate;

[Note] Click to select the box and drag the 4 yellow points at the corners to adjust the length and width of it; long-press on the box to select it and drag it to proper positions.

- b) Click “**Play**” and when the vehicle plate comes to the bottom of the image, click “**Pause**”. Adjust the size and position of the “Near” box to make it the same width as that of the plate;

[Note] During calibration, do not adjust the field of view, i.e. do not click the zoom in or zoom out icons.

Calibration diagram Enable NearFarBoxFlag
 Enable PriorAreaFlag

Preset
1

AlgPreset-1

Play Pause Save Reset

- 3) Configure prior area. When "Enable Prior Area Flag" is unselected, the default prior area of the camera is full area; after selecting "Enable Prior Area Flag", when an object enters the prior area, the camera will output the optimum snapshots in this area first.

[Note] Prior area configuration is used to capture human face and vehicles.

In actual scenes, especially when the supplementary light at night can only cover partial area, prior area configuration is necessary. The configuration steps are as follows:

- Go to **Intelligent > Settings > Calibration**, and select **"Enable Prior Area Flag"** to display the prior area. The default prior area is 1/2 to 3/4 part from the top of the image.
 - Click the prior area frame and drag the yellow points at the corners to adjust the length and width of the area; long-press on the blue lines of the frame and drag the frame to move it to a proper position.
- 4) Click **"Save"** to validate settings.

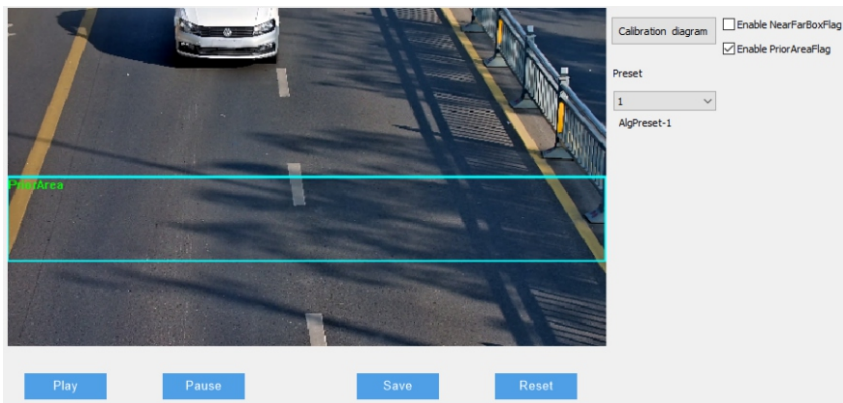

Appendix I: Reference of Installation Parameters

The following table is the reference parameters when installing the camera at the recommended angle of pitch, i.e. 13°.

[Note] Optimum surveillance distance means the horizontal distance between the lower middle part of the image and the camera.

2.0 MP			
Installation Height	Angle of Pitch	Optimum Surveillance Distance	Surveillance Width
4m	13°	8~11m	5m
5m	13°	12~15m	5m
6m	13°	16~19m	5m
7m	13°	20~23m	5m
4.0 MP			
Installation Height	Angle of Pitch	Optimum Surveillance Distance	Surveillance Width
4m	13°	7~11m	6m
5m	13°	11~15m	6m
6m	13°	15~19m	6m
7m	13°	18.5~23.5m	6m

[Note] The angle and lens direction of PTZ camera are variable, which makes it flexible and enables larger surveillance scope.

Appendix II:

Waterproof

- For outdoor mounting, suggest applying wall mounting bracket whose cross-bar has an upward angle.
- If user uses self-selected bracket, suggest applying those waterproof brackets with female screw thread connector. If user selects brackets with male screw thread, make sure of the waterproofness of the connecting part between the bracket and the high speed dome camera.
- The screw thread connector needs to be bound with thread seal tape to ensure the sealing tightness of screw thread. When mount, align with the screw thread to avoid obvious deviation or slipping.
- The O-ring seal for the transparent housing of dome camera must be mounted to prevent vapor or dust penetration.

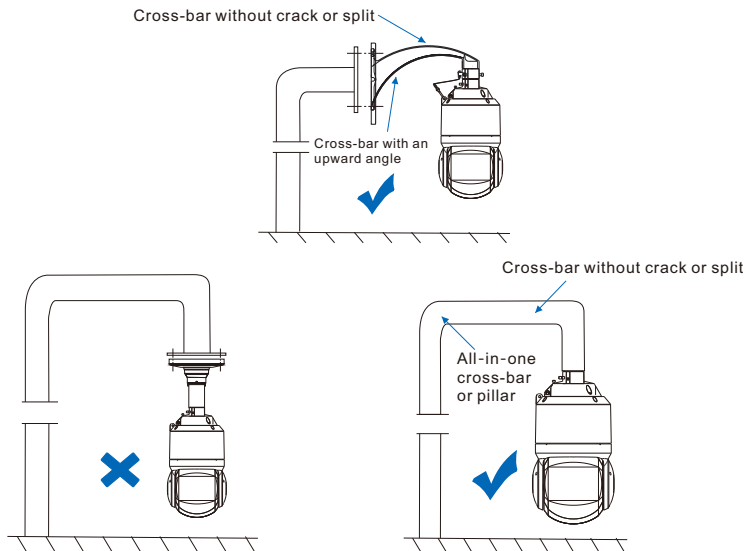

Anti-static, Anti-interference, Anti-thunder, Anti-surge

- The camera should be grounded, or ESD may damage the electrical parts.
- In thunder and lightning area, camera should be grounded nearby to release the heavy energy of thunder strike so as to prevent camera from damage.
- In area with unstable voltage, camera should be grounded to release the heavy energy of electrical surge so as to prevent power source from burning.
- Camera anti-thunder ground lead cannot replace safety ground lead. When apply pillars with imperfect earth, such as wooden pillar and cement pillar, camera should connect the safety ground lead to release leak current so as to ensure the safety of camera or pillar.
- Camera anti-thunder ground lead must be grounded individually, other than being grounded through other electrical device nearby.

[Cement Pillar Ground]

Cement pillar mounting needs protective steel pipe to lead the ground wire. As the picture shows, the ground wire of high speed dome camera goes through the steel pipe and grounds. The Command Center just has to ground locally according to the norms.

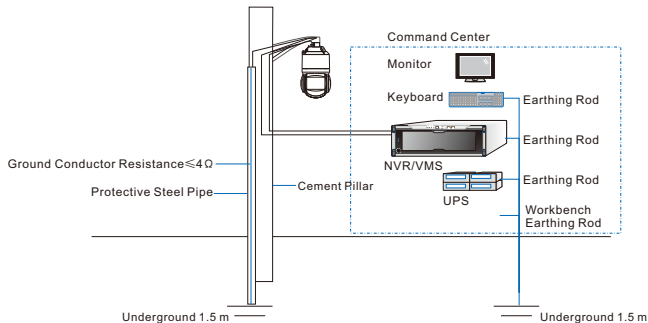

Cement Pillar Ground

[Metal Pillar Ground]

Metal pillar mounting needs PVC pipe to lead the ground wire. Metal pillar without lightning rod applies PVC pipe to lead ground wire. Fix the ground wire near the metal pillar and ground it, as the picture shows.

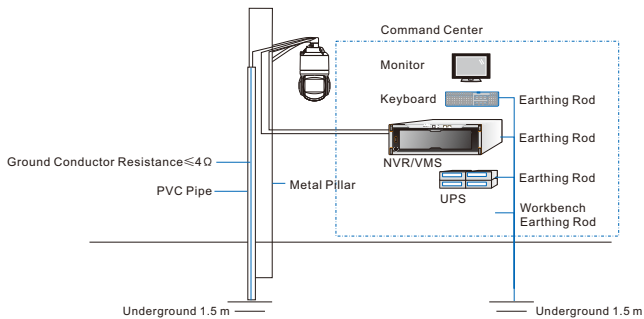

Metal Pillar Ground without Lightning Rod

Metal pillar with lightning rod applies inside PVC pipe to lead ground wire, and the PVC pipe should keep an insulation distance from the inner wall of metal pillar as far as possible, as the picture shows.

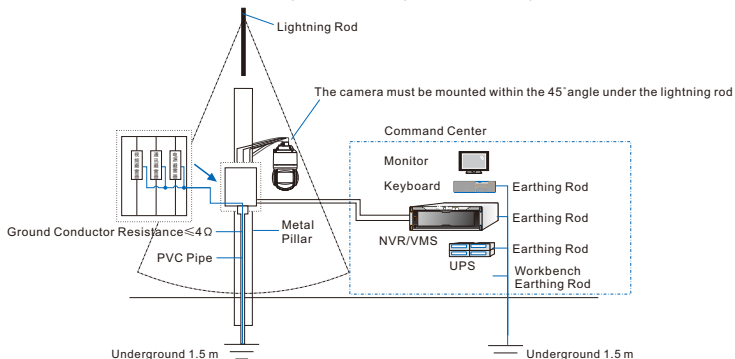

Metal Pillar Ground with Lightning Rod

[Attention]: If there is middleware installed, such as optical transceiver or anti-thunder device, the middleware should be well grounded and the camera should also be well grounded if the cable goes through the middleware.

Appendix III: AC 24V Wire Diameter VS. Transmission Distance

The recommended max transmission distance when the wire diameter is certain and the AC24V voltage loss rate is less than 10%

(For AC24V powered devices, the maximum allowed voltage loss rate is 10%. All the wires in the following table are cooper wires, whose electrical resistivity is $\rho = 0.0175\Omega \cdot \text{mm}^2/\text{m}$)

Distance m (feet) Power W	Diameter mm 0.8 (20AWG)	1.0(18AWG)	1.25(16AWG)	2.0(12AWG)
5	122 (401)	194 (636)	307 (1008)	781 (2562)
10	61 (201)	97 (318)	154 (504)	391 (1281)
15	41 (134)	65 (212)	102 (336)	260 (854)
20	31 (100)	48 (159)	77 (252)	195 (641)
25	24 (80)	39 (127)	61 (202)	156 (512)
30	20 (67)	32 (106)	51 (168)	130 (427)
35	17 (57)	28 (91)	44 (144)	112 (366)
40	15 (50)	24 (79)	38 (126)	98 (320)
45	14 (45)	22 (71)	34 (112)	87 (285)
50	12 (40)	19 (64)	31 (101)	78 (256)
55	11 (36)	18 (58)	28 (92)	71 (233)
60	10 (33)	16 (53)	26 (84)	65 (214)
65	9 (31)	15 (49)	24 (78)	60 (197)
70	9 (29)	14 (45)	22 (72)	56 (183)
75	8 (27)	13 (42)	20 (67)	52 (171)
80	8 (25)	12 (40)	19 (63)	49 (160)
85	7 (23)	11 (37)	18 (59)	46 (151)
90	7 (22)	11 (35)	17 (56)	43 (142)
95	6 (21)	10 (33)	16 (53)	41 (135)
100	6 (20)	10 (32)	15 (50)	39 (128)

[Note]: The requirements of diameter apply to single, solid and round cooper wire. The AWG value of multi-stranded wires depends on the total CSA (Cross Sectional Area) of all wires.

Kedacom Two (2) Year Limited Hardware Warranty

WHAT IS COVERED BY THIS WARRANTY?

Kedacom warrants the Kedacom-branded hardware product and accessories contained in the original packaging (hereinafter referred to as "Kedacom Product") against defects in materials and workmanship when used normally in accordance with Kedacom's published guidelines for a period of TWO (2) YEARS from the date of original retail purchase in areas other than mainland China by the end-user purchaser (hereinafter referred to as "Warranty Period"). For the Kedacom Product purchased in mainland China, see the simplified Chinese version of this warranty for details. Kedacom's published guidelines include but are not limited to information contained in technical specifications, user guides, and service communications. The preceding applies unless otherwise agreed in the contract.

WHAT IS NOT COVERED BY THIS WARRANTY?

This warranty does not apply to any non-Kedacom branded hardware products or any software, even if packaged or sold with Kedacom hardware. Manufacturers, suppliers, or publishers, other than Kedacom, may provide their own warranties to you but Kedacom, in so far as permitted by law, provides their products "AS IS". Software distributed by Kedacom with or without the Kedacom brand (including, but not limited to system software) is not covered by this warranty. Please refer to the licensing agreement accompanying the software for details of your rights with respect to its use. Kedacom does not warrant that the operation of the Kedacom Product will be uninterrupted or error-free. Kedacom is not responsible for damage arising from failures to follow instructions relating to the Kedacom Product's use.

This warranty does not apply: (a) to consumable parts, such as batteries, unless failure has occurred due to a defect in materials or workmanship; (b) to cosmetic damage, including but not limited to scratches, dents, and broken plastic on ports; (c) to damage caused by use with another product; (d) to damage caused by acts outside the control of Kedacom, including without limitation acts of God, accidents, abuse, misuse, fire, storms, earthquakes, flood, or other external cause; (e) to damage caused by exposure of the product to heat, bright light, sun, liquids, sand, or other contaminants; (f) to damage caused by operating the Kedacom Product outside Kedacom's published guidelines; (g) to damage caused by service (including upgrades and expansions) performed by anyone other than a representative of Kedacom, Kedacom employee, or authorized Kedacom agent; (h) to an Kedacom Product that has been modified to alter functionality or capability without the written permission of Kedacom; (i) to defects caused by normal wear and tear or otherwise due to the normal aging of the Kedacom Product, or (j) if any serial number has been removed or defaced from the Kedacom Product.

YOUR RESPONSIBILITIES

If your Kedacom product is capable of storing data and other information, you should make periodic backup copies of the information contained on the storage media to protect the contents and as a precaution against possible operational failures.

Before receiving warranty service, Kedacom or its authorized agents may require that you furnish proof of purchase details, respond to questions designed to assist with diagnosing potential issues, and follow Kedacom's procedures for obtaining warranty service. Before submitting your Kedacom Product for warranty service, you should maintain a separate backup copy of the contents of its storage media, remove all personal information that you want to protect, and disable all security passwords.

During warranty service, it is possible that the contents of the Kedacom product's storage media will be lost, replaced or reformatted. In such an event, Kedacom and its authorized agents are not responsible for any loss of data or other information contained on the storage media or any other part of the Kedacom product serviced.

Following warranty service, your Kedacom Product or a replacement product will be returned to you as your Kedacom Product was configured when originally purchased, subject to applicable updates. You will be responsible for reinstalling all other data and information. Recovery and reinstallation of other data and information are not covered under this warranty.

WHAT WILL KEDACOM DO IF THE WARRANTY IS BREACHED?

If during the Warranty Period, you submit a valid claim to Kedacom or an authorized Kedacom agent, Kedacom will, at its option, (i) repair the Kedacom Product using new or previously used parts that are equivalent to new in performance and reliability, or (ii) exchange the Kedacom Product for a refund of your purchase price.

A Kedacom replacement part or product, including a user-installable Kedacom part that has been installed in accordance with instructions provided by Kedacom, assumes the remaining warranty of the Kedacom Product or ninety (90) days from the date of replacement or repair, whichever provides longer coverage for you. When a product or part is replaced or a refund provided, any replacement item becomes your property and the replaced or refunded item becomes Kedacom's property.

Kedacom reserves the right to refund the purchase price as its exclusive warranty remedy.

HOW TO OBTAIN WARRANTY SERVICE?

To seek warranty service, please contact a local authorized Kedacom agent. When contacting the agent via telephone, other charges may apply depending on your location.

User Information

Complete the form below and keep for ready reference.

User Name:	
Address:	Postal Code:
Tel:	Mobile:
Fax:	E-Mail:
Product Name:	Product Model:
Date of Purchase:	

客户咨询热线：400-828-2866

KEDACOM

苏州科达科技股份有限公司

Suzhou Keda Technology Co.,Ltd.

中国: 江苏省苏州市高新区金山路131号(215011)

Tel: +86-512-6841 8188 Fax: 86-512-68412699

Suzhou Keda Technology Co.,Ltd.

Singapore: 627A Aljunied Road, #09-07, BizTech Centre, Singapore 389842

Tel: +65-6842-5700 Fax: +65-6842-5900

05.03.800944 (V1.2) 20200424